

# XTF 1.5 All Track

Variante colore:  
**green**





Colore: **grey**

## Specifiche tecniche

 Aluminum, sizes: S - M - L

 <sup>90 Nm</sup> Yamaha PW X3,  
Torque/Coppia: 85 Nm

 Fantic, Lithium Ion, 36 Volt, 630Wh

 RockShox Recon Silver RL 150mm

 RockShox Deluxe Select

## Puntone del carro in "injected composite"

 Sram SX, 12V, 11-50

 Sram Level 2 Piston disc brake

 Rodi TRYP30 - 29"

 Pirelli Scorpion ProWall Trail

 Selle Italia MODEL-X  
Comfort Superflow 145

(\*) FANTIC MOTOR si riserva il diritto di modificare le caratteristiche tecniche elencate, senza alcun obbligo di preavviso.  
Tutte le immagini sono inserite a scopo illustrativo. I prodotti possono subire modifiche.



(\*) FANTIC MOTOR si riserva il diritto di modificare le caratteristiche tecniche elencate, senza alcun obbligo di preavviso. Tutte le immagini sono inserite a scopo illustrativo. I prodotti possono subire modifiche.

# XTF 1.5

## All

## Track

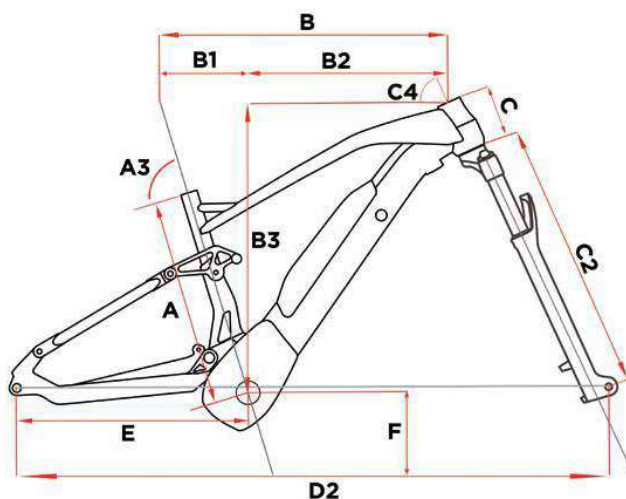

<b>Motore</b>	Yamaha PW X3, Torque/Coppia: 85 Nm
<b>Batteria</b>	Fantic, Lithium Ion, 36 Volt, 630Wh
<b>Display</b>	Yamaha Interface X
<b>Telaio</b>	Aluminum, sizes: S - M - L
<b>Forcella (**)</b>	RockShox Recon Silver RL 150mm
<b>Ammortizzatore</b>	RockShox Deluxe Select
<b>Corona</b>	Sram 34t
<b>Pedivelle</b>	FSA
<b>Deragliatore</b>	Sram SX
<b>Comandi cambio</b>	Sram SX Eagle
<b>Cassetta</b>	Sram SX, 12V, 11-50
<b>Catena</b>	Sram SX
<b>Freno ant.</b>	Sram Level 2 Piston disc brake
<b>Freno post.</b>	Sram Level 2 Piston disc brake
<b>Disco ant.</b>	SramCenterLine, 200mm - 6Hole
<b>Disco post.</b>	SramCenterLine, 180mm - 6Hole
<b>Pneumatici ant.</b>	Pirelli Scorpion ProWall Trail -M- 29"x 2.4
<b>Pneumatici post.</b>	Pirelli Scorpion ProWall Trail -R- 29"x 2.4
<b>Ruote</b>	Rodi TRYP30 - 29"
<b>Manubrio</b>	Promax-760mm-Rise 18mm-ø31,8
<b>Attacco manubrio</b>	Promax-60mm-Rise+6"-ø31,8
<b>Reggisella</b>	RST ELEV8 A2 Ø 30.9, S - 80mm / M - 100mm / L - 125mm
<b>Sella</b>	Selle Italia Model-X Comfort Superflow 145
<b>Note</b>	(*)
(**) Alternative fork / forcella alternativa Suntour Auron 35	

Misure	S	M	L
<b>A</b>	390	430	490
<b>A3</b>	73	73	73
<b>B</b>	575	602	627
<b>B1</b>	166	169	174
<b>B2</b>	407	433	453
<b>B3</b>	615,8	625,0	641,5
<b>C</b>	105	115	130
<b>C2</b>	567	567	567
<b>C4</b>	66	66	66,5
<b>D1</b>	1193	1224	1244
<b>E</b>	472	472	472
<b>F</b>	358	358	358

(\*) FANTIC MOTOR si riserva il diritto di modificare le caratteristiche tecniche elencate, senza alcun obbligo di preavviso. Tutte le immagini sono inserite a scopo illustrativo. I prodotti possono subire modifiche.



**@fanticbikes**



**Fantic Bikes**



**Fantic Bikes**



**Fantic Motor**



**@fanticmotor\_official**

**fantic.com**

**FANTIC**

**Fantic,**  
**disegniamo,**  
**progettiamo**  
**ed assembliamo**  
**bici elettriche**  
**ad alte**  
**prestazioni.**

Fantic Motor S.P.A.  
Via Tarantelli, 7  
31030 Dossan di Casier (TV) Italy  
info@fanticmotor.it  
[fantic.com](http://fantic.com)