

XTF 1.5 Race-Y

Variante colore:
green



Colore: **grey**

Specifiche tecniche

 Aluminum, sizes: S - M - L

 ^{90 Nm} Yamaha PW X3,
Torque/Coppia: 85 Nm

 Fantic, Lithium Ion, 36 Volt, 630Wh

 RockShox 35 Gold RL - 29" 150mm

 RockShox Deluxe Select+

Puntone del carro in "injected composite"

 Sram SX, 12V, 11-50

 Sram Guide T 4 Piston disc brake

 Rodi TRYP30 - 29"

 Pirelli Scorpion ProWall Trail

 Selle Italia Model-X
Comfort Superflow 145

(*) FANTIC MOTOR si riserva il diritto di modificare le caratteristiche tecniche elencate, senza alcun obbligo di preavviso.
Tutte le immagini sono inserite a scopo illustrativo. I prodotti possono subire modifiche.



(*) FANTIC MOTOR si riserva il diritto di modificare le caratteristiche tecniche elencate, senza alcun obbligo di preavviso. Tutte le immagini sono inserite a scopo illustrativo. I prodotti possono subire modifiche.

XTF 1.5 Race-Y

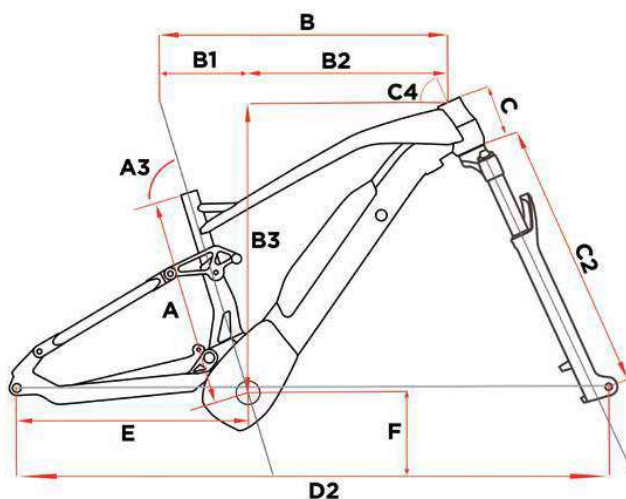

Motore	Yamaha PW X3, Torque/Coppia: 85 Nm
Batteria	Fantic, Lithium Ion, 36 Volt, 630Wh
Display	Yamaha Interface X
Telaio	Aluminum, sizes: S - M - L
Forcella (**)	RockShox 35 Gold RL - 29" 150mm
Ammortizzatore	RockShox Deluxe Select+
Corona	Sram 34t
Pedivelle	FSA
Deragliatore	Sram GX AXS
Comandi cambio	Sram GX AXS Eagle
Cassetta	Sram SX, 12V, 11-50
Catena	Sram SX
Freno ant.	Sram Guide T 4 Piston disc brake
Freno post.	Sram Guide T 4 Piston disc brake
Disco ant.	SramCenterLine, 200mm - 6Hole
Disco post.	SramCenterLine, 180mm - 6Hole
Pneumatici ant.	Pirelli Scorpion ProWall Trail -M- 29"x 2.4
Pneumatici post.	Pirelli Scorpion ProWall Trail -R- 29"x 2.4
Ruote	Rodi TRYP30 - 29"
Manubrio	FSA 760mm- Ø31,8 - Rise 15mm - Sweep 6°
Attacco manubrio	FSA Logo-60mm-Ø31,8 - Rise +6°
Reggisella	Switch SW Ø 30,9, S - 80mm / M - 100mm / L - 125mm
Sella	Selle Italia Model-X Comfort Superflow 145
Note	(*)
(**) Alternative fork / forcella alternativa Suntour Auron 35	

Misure	S	M	L
A	390	430	490
A3	73	73	73
B	575	602	627
B1	166	169	174
B2	407	433	453
B3	615,8	625,0	641,5
C	105	115	130
C2	567	567	567
C4	66	66	66,5
D1	1193	1224	1244
E	472	472	472
F	358	358	358

(*) FANTIC MOTOR si riserva il diritto di modificare le caratteristiche tecniche elencate, senza alcun obbligo di preavviso.
Tutte le immagini sono inserite a scopo illustrativo. I prodotti possono subire modifiche.



@fanticbikes



Fantic Bikes



Fantic Bikes



Fantic Motor



@fanticmotor_official

fantic.com

FANTIC

Fantic,
disegniamo,
progettiamo
ed assembliamo
bici elettriche
ad alte
prestazioni.

Fantic Motor S.P.A.
Via Tarantelli, 7
31030 Dossan di Casier (TV) Italy
info@fanticmotor.it
fantic.com